

ESENA

1D1W

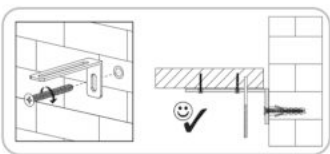

Ø5
Ø8

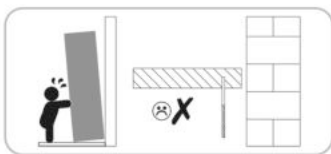
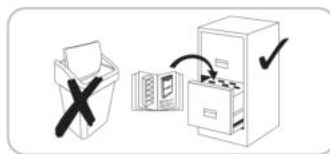
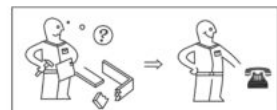
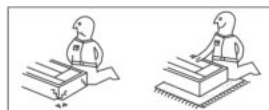
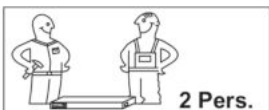
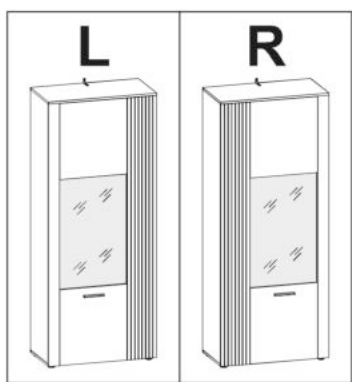
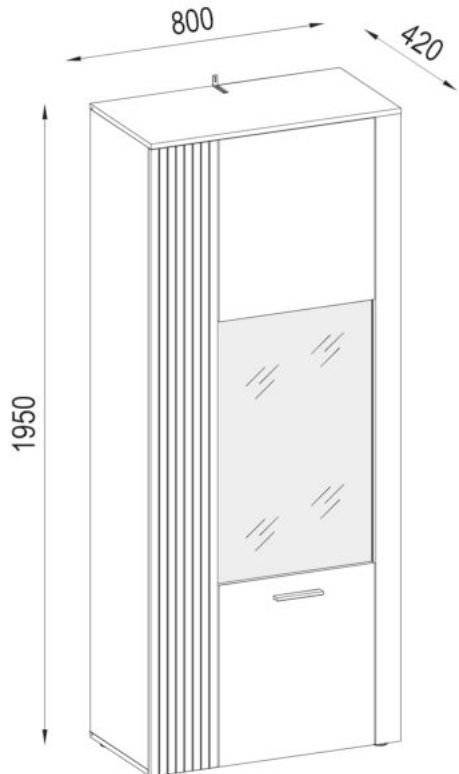

- pevne dotiahnut
- zatlačiť
- odmerať
- stlačiť
- zabiť
- otočiť - obrátiť

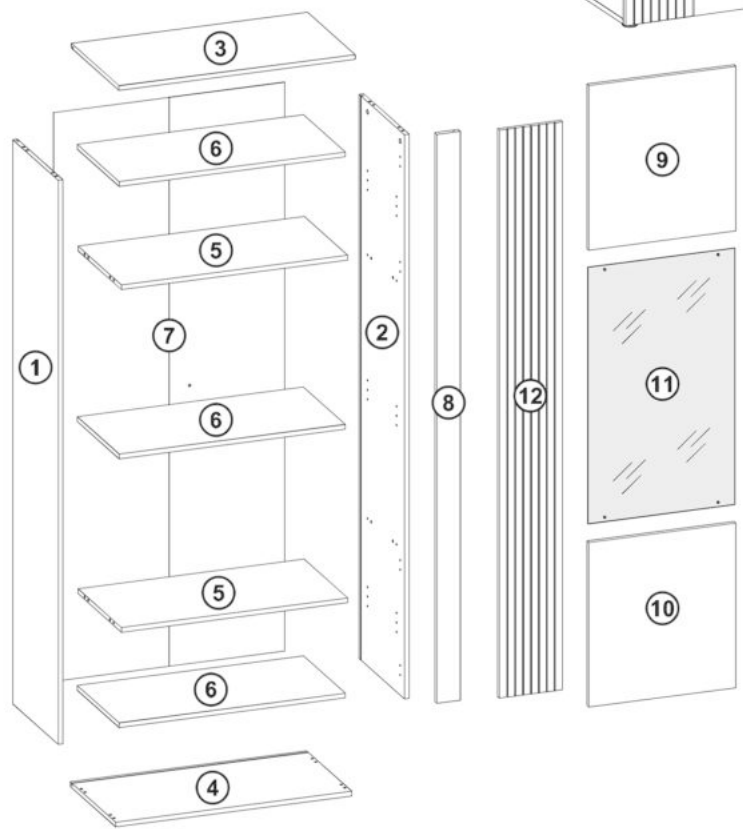





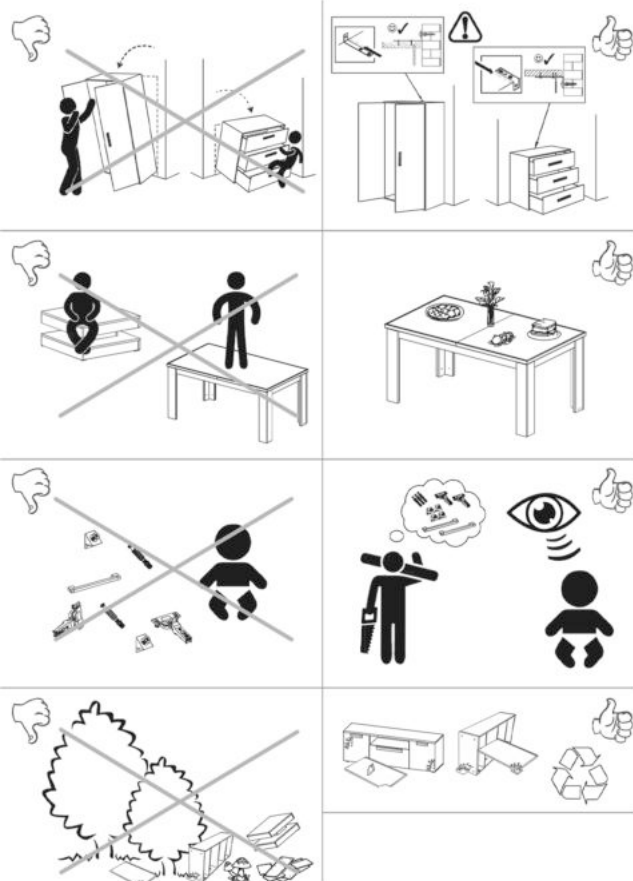









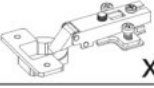





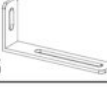

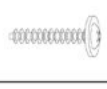
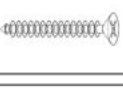
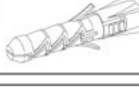
A	B (mm)		C	D
1	1898	400	16	x1 2/2
2	1898	400	16	x1 2/2
3	800	420	16	x1 1/2
4	800	400	16	x1 1/2
5	766	384	16	x2 1/2
6	766	370	16	x3 1/2
7	1914	782	2,5	x1 2/2

A	B (mm)		C	D
8	1914	80	18	x1 2/2
9	554	498	16	x1 2/2
10	554	498	16	x1 2/2
11	863	498	4	x1 2/2
12	1911	214	16	x1 2/2
B1				1/2



B1 1/2

A1 15x12  x12	C2 44mm  x12	B2 8x30  x16
FA1 4mm  x1	F3 6,3x50  x4	O3 Ø18  x8
K6 Ø35  x4	J65 128/148  x1	O4 Ø18  x4
M1 10x10x15  x14	P14 45x20  x4	N1 Ø6  x12
Y36 75x32x15  x1	N5 10x6x10  x4	DB2 4x25  x2
D25 4x25  x4	Y37 8x50  x1	Y35 4,2x65  x1
DA21 4,2x16  x24	D11 3,5x16  x18	R10 Ø10  x4
T1 30x35x55  x4	K9 Ø35  x4	O5 Ø8  x2

Náš nábytok sa musí používať podľa predpisov. Použitie v rozpore s predpismi môže viesť k vecným škodám a za istých okolností aj k zraneniam osôb. Nábytok nie je hračka. Za škody, ktoré vzniknú používaním proti predpisom alebo nesprávnou manipuláciou, nepreberá výrobca alebo predajca žiadnu záruku.

POZOR: Deti alebo osoby s mentálnym postihnutím sa musia neustále držať mimo častí nábytku, špicatých predmetov, drobných častí a obalových materiálov, pretože hrozí riziko zranenia a/alebo udusenía.

MONTÁŽ: Pri montáži dodržiavajte náš návod na používanie, obsluhu, inštaláciu alebo montáž a dávajte hlavne pozor na výstražné a bezpečnostné pokyny. Pokiaľ sa nebudú dodržiavať predpisy, môže to mať za následok zranenie osôb alebo poškodenie nábytku/ohrozenie bezpečnosti. Ak by ste mali problémy s inštaláciou/montážou, kontaktujte náš servisný tím. Ohotne vám poradí a pomôže. Montáž smie vykonávať iba kvalifikovaný personál. Pri zmenách na produkte/dieloch produktu, pri výmene alebo použití dielov/spotrebných materiálov, ktoré nepochádzajú od výrobcu/predajcu, nepreberáme žiadnu zodpovednosť za škody.

Pokiaľ sú k tovaru priložené upevňovacie prvky na stenu, ako sú hmoždinky a skrutky, sú tieto určené výhradne na použitie na stenách z pevných a jednoliatych materiálov. Upevnenie je len tak dobré, ako dobré je spojenie medzi upevňovacím prostriedkom a stenou. Pred upevnením musíte skontrolovať vhodnosť vašej steny pre stojaci aj zdviesny nábytok a použiť iba vhodné spojovacie prvky. Pred prípadným vitaním sa uistite, že sa v oblasti vitania nenachádzajú elektrické vodiče. Nakoniec je za upevnenie na stenu zodpovedný inštalčný technik.

Platí to aj pre inštaláciu elektrických produktov a ďalšieho stavebno-technického príslušenstva. Montáž/inštaláciu elektrických produktov a tiež ďalšieho dôležitého konštrukčného príslušenstva môže vykonávať iba autorizovaný kvalifikovaný personál. Všetky elektrické a stavebno-technické inštalácie musia byť vykonané v súlade s platnými normami a bezpečnostnými predpismi vo vašej krajine. Pre svetelné zdroje používajte iba povolenú intenzitu osvetlenia. Pri nedodržaní max. počtu Watt hrozí riziko požiaru v dôsledku prehriatia. Prekrývanie svietidiel nie je povolené z dôvodu rizika požiaru. Dokonalá funkcia nábytku je zaručená iba pri vertikálnej a horizontálnej inštalácii. Dvere sú vopred nastavené, môžu sa ale znova nastaviť na základe miestnych podmienok. Dodržiavajte údaje o hmotnosti pre maximálne zaťaženie. Na nábytok sa nesmie liezť. Pri neodbornom použití môže dôjsť k prevráteniu nábytku. Aby sa tomu zabránilo, musí byť nábytok neustále zaistený proti prevráteniu. Pri preťažení/nadmernom preťažení (najmä hrajúcimi sa deťmi, ľuďmi, materiálom alebo inými nevhodnými vplyvmi) hrozí riziko rozbitia a zranenia. Všetky skrutky a nosné spojovacie miesta by mali byť dotiahnuté po 5 až 6 týždňoch, aby sa zaistila trvalá stabilita.

STAROSTLIVOSŤ: Pokyny pre starostlivosť o nábytok - Dodržiavajte naše pokyny pre správnu starostlivosť o nábytok, aby ste si náš výrobok mohli užívať čo najdlhšie. Pri čistení používajte čistú, suchú a mäkkú bavlnenú handričku. Pokiaľ potrebuje váš nábytok dôkladné vyčistenie, môžete handričku navlhčiť trochu vody alebo čistiaceho prostriedku na nábytok a potom vyčistené diely vysušiť. Kovové a sklenené diely sa najlepšie čistia bežne dostupnými čistiacimi prostriedkami na kov a sklo podľa pokynov uvedených na výrobku. Na čistiacich prostriedkoch musí byť jasne uvedené, že sú vhodné na čistenie nábytku. V žiadnom prípade nepoužívajte pamé čističe, žieraviny, abrazíva alebo iné prostriedky, ktorých účinky nepoznáte. **POZOR:** Vysoko lesklé povrchy sú pri dodávke chránené ochrannou fóliou. Nechajte fóliu na nábytku, kým nebude úplne zmontovaný a zbavený prachu. Vysoko lesklé prvky, z ktorých bola odstránená ochranná fólia, je možné čistiť a používať až po 72 hodinách (doba pre následné vytvrdnutie na okolitom vzduchu).

Povrchy nemožno poškodiť ostrými predmetmi a nikdy ich nemôžete vystavovať silnému snečnému žiareniu.

LIKVIDÁCIA

- Pokyny na likvidáciu odpadu -

V záujme ochrany životného prostredia vyhadzujte obalový odpad roztriedený podľa druhu do určených odpadkových/recyklačných nádob, v žiadnom prípade nevyhadzujte do prírody. Poškodený alebo nepoužiteľný nábytok je možné odoslať do špeciálnych zberných zariadení na recykliáciu jednotlivých dielov. Použitý, ale stále funkčný nábytok nie je nutné hneď likvidovať. Darujte ho napr. charitatívnym organizáciám.

Prajeme vám veľa zábavy s vašim novým nábytkom.

1

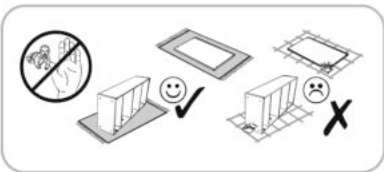

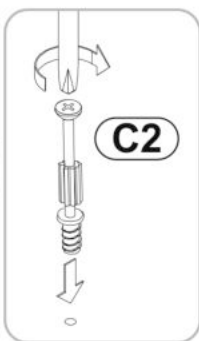
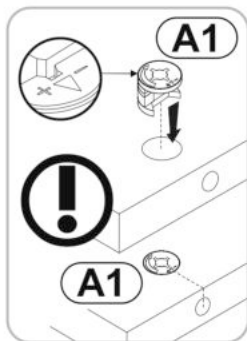
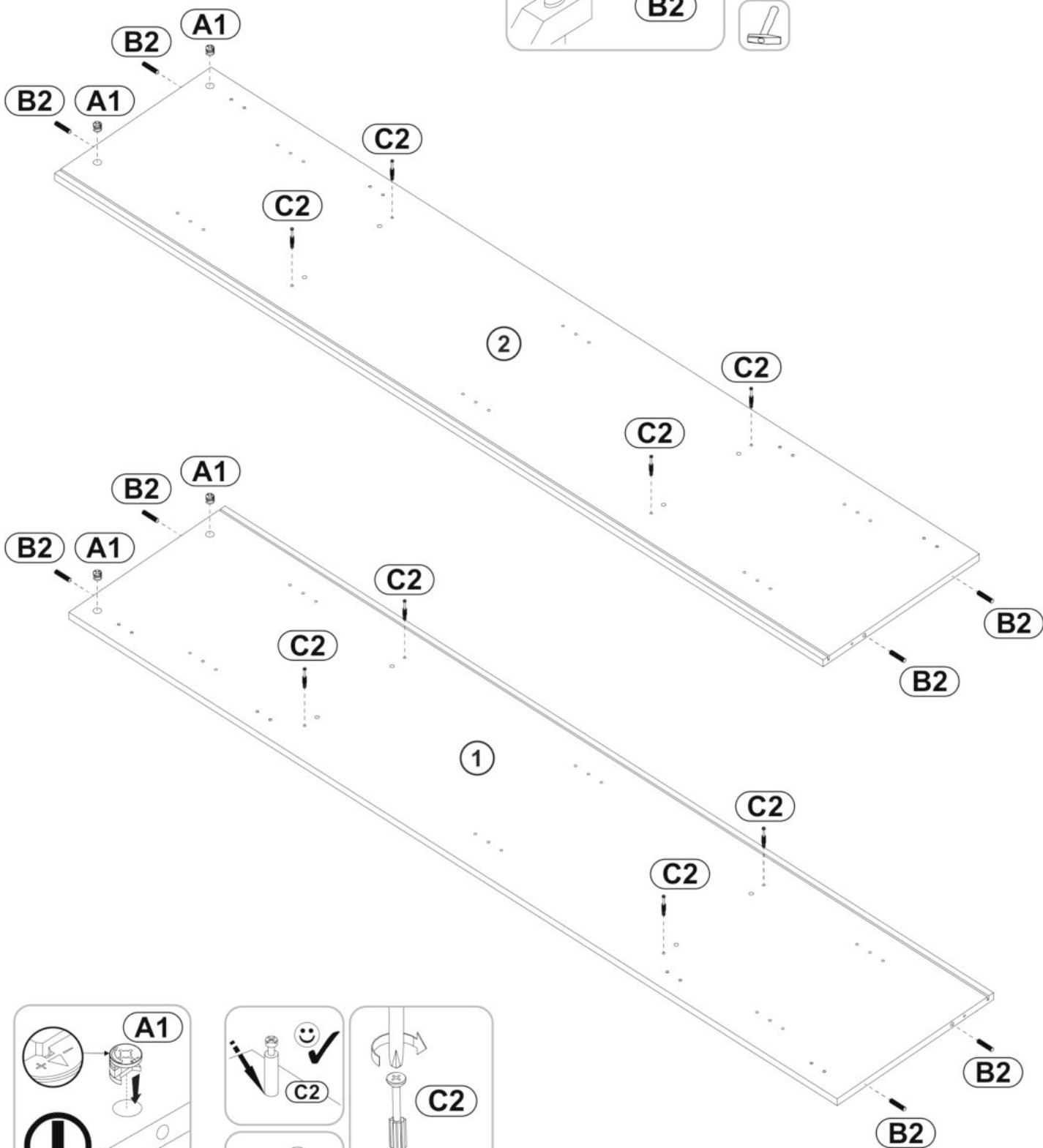
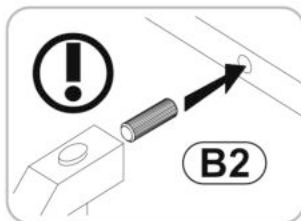

A1		x4
C2		x8
B2		x8

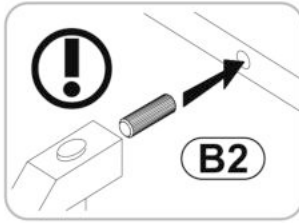
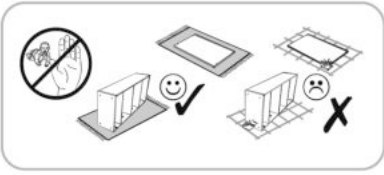

2



A1  **x8**
15x12

C2  **x4**
44mm

B2  **x8**
8x30

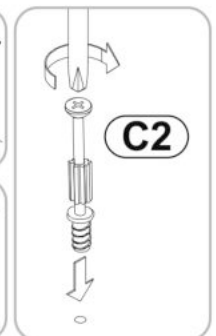
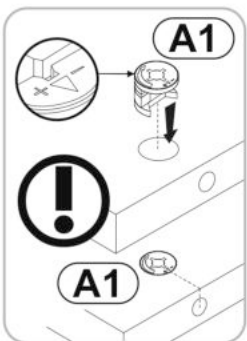
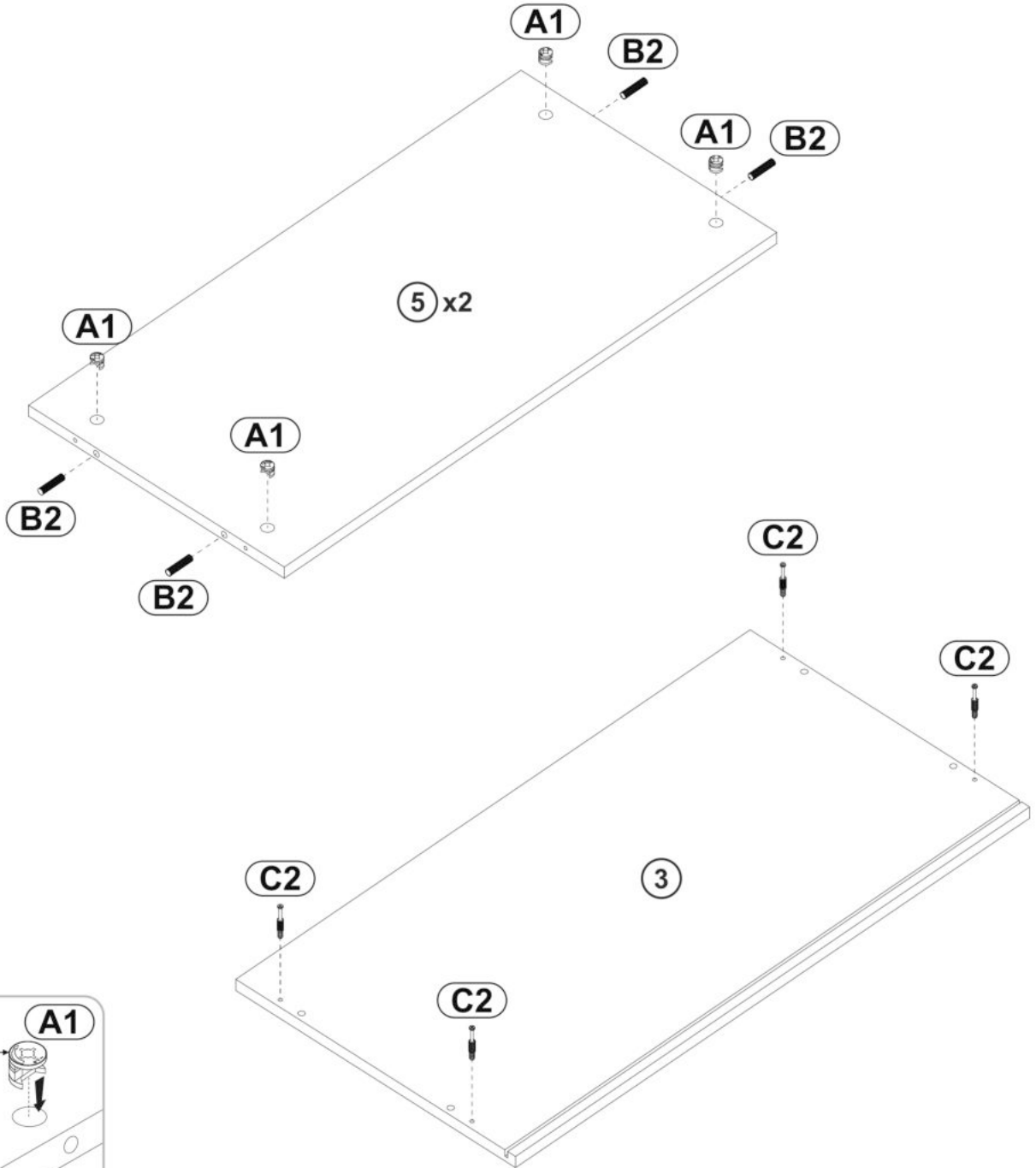

3

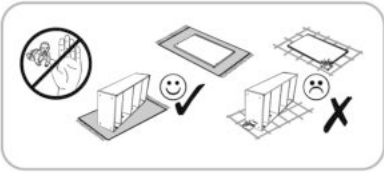

- DA21**
4,2x16 x8
- T1**
30x35x55 x4
- K9**
Ø35 x4

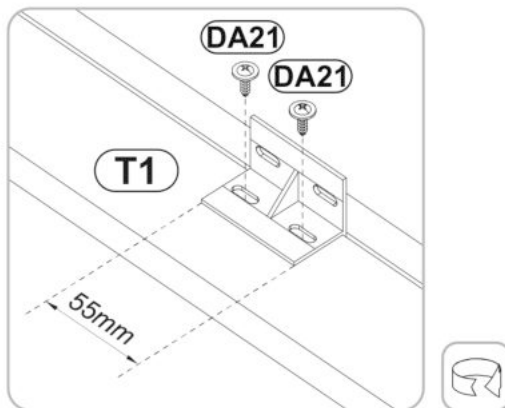
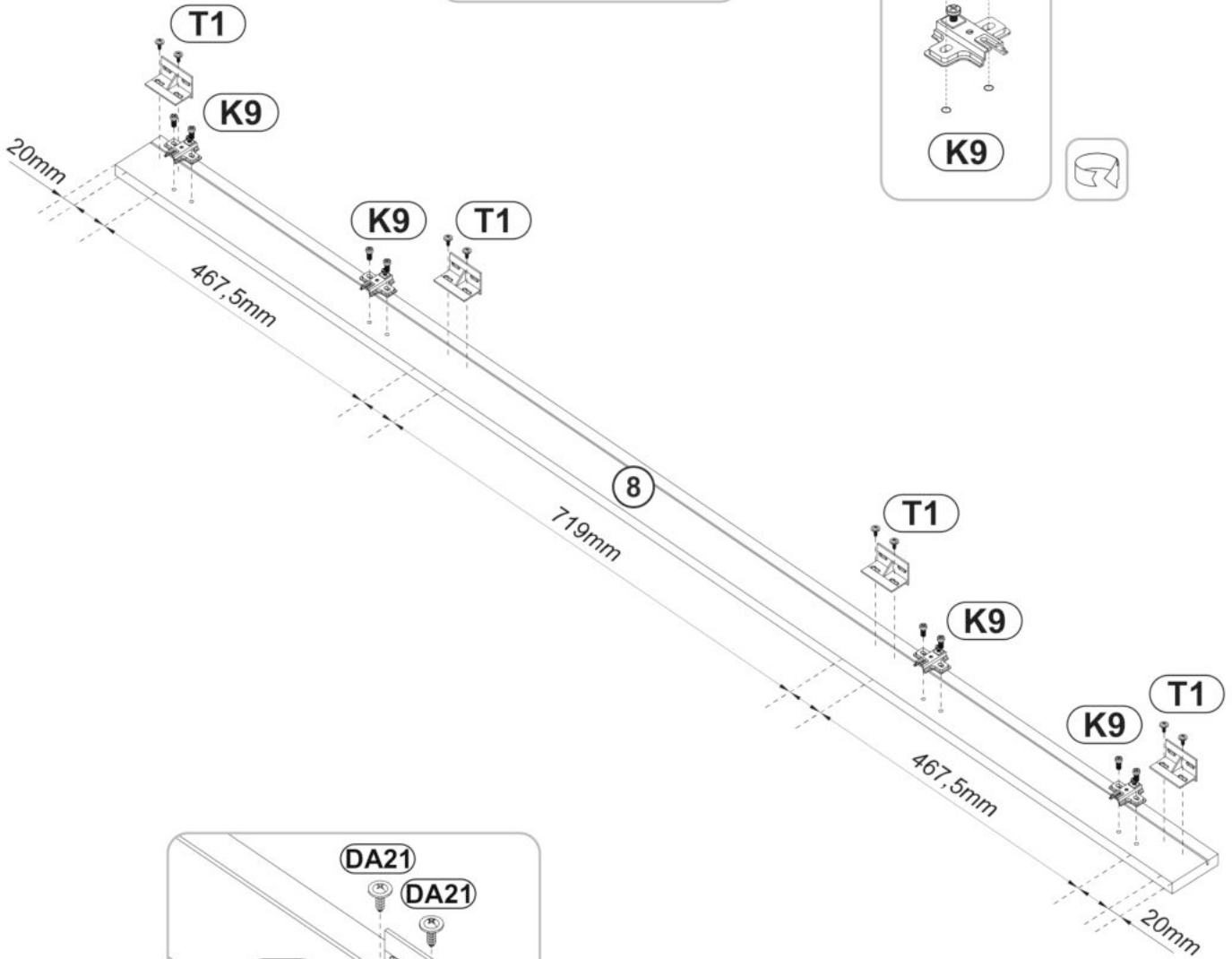
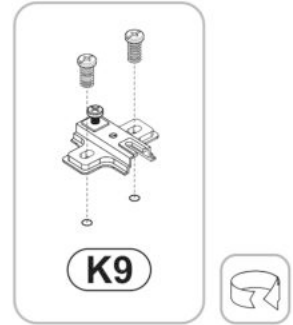
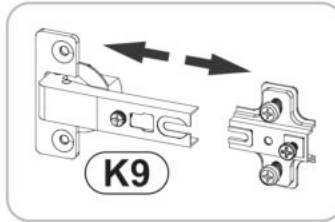

4

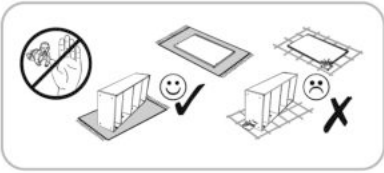

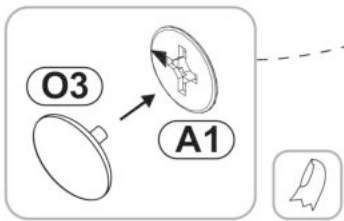
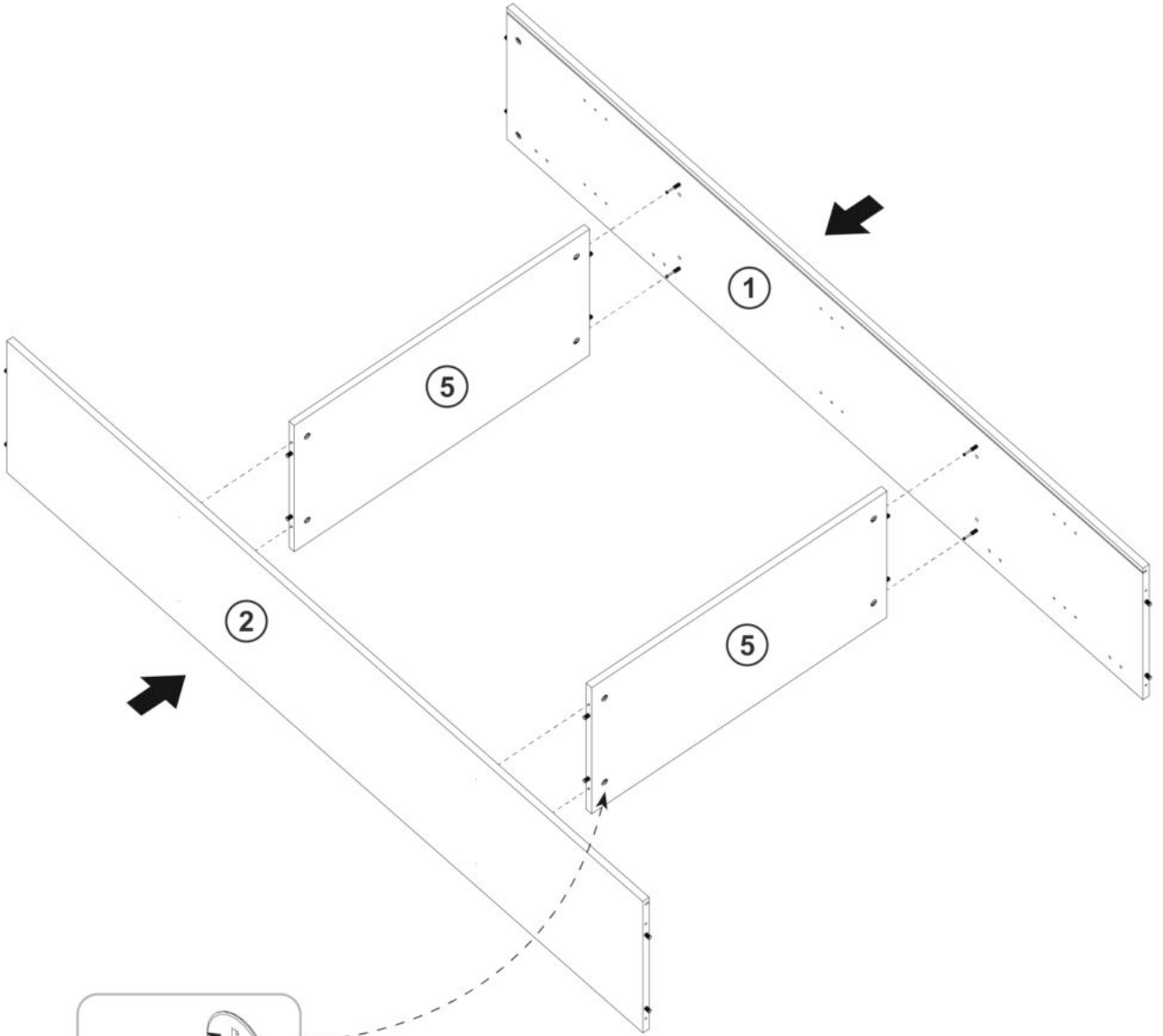
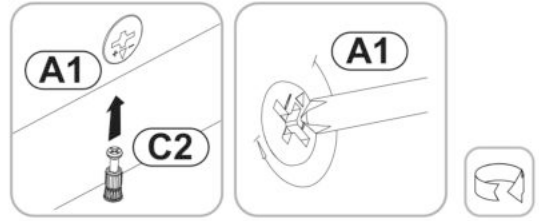

O3
Ø18 x8

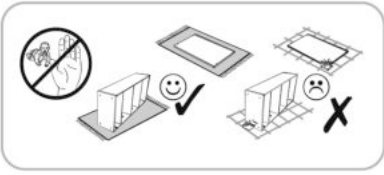

5

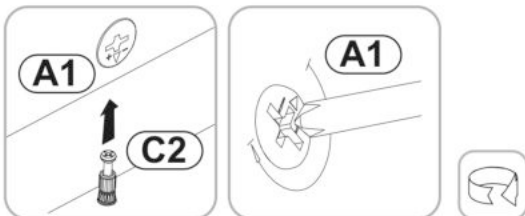
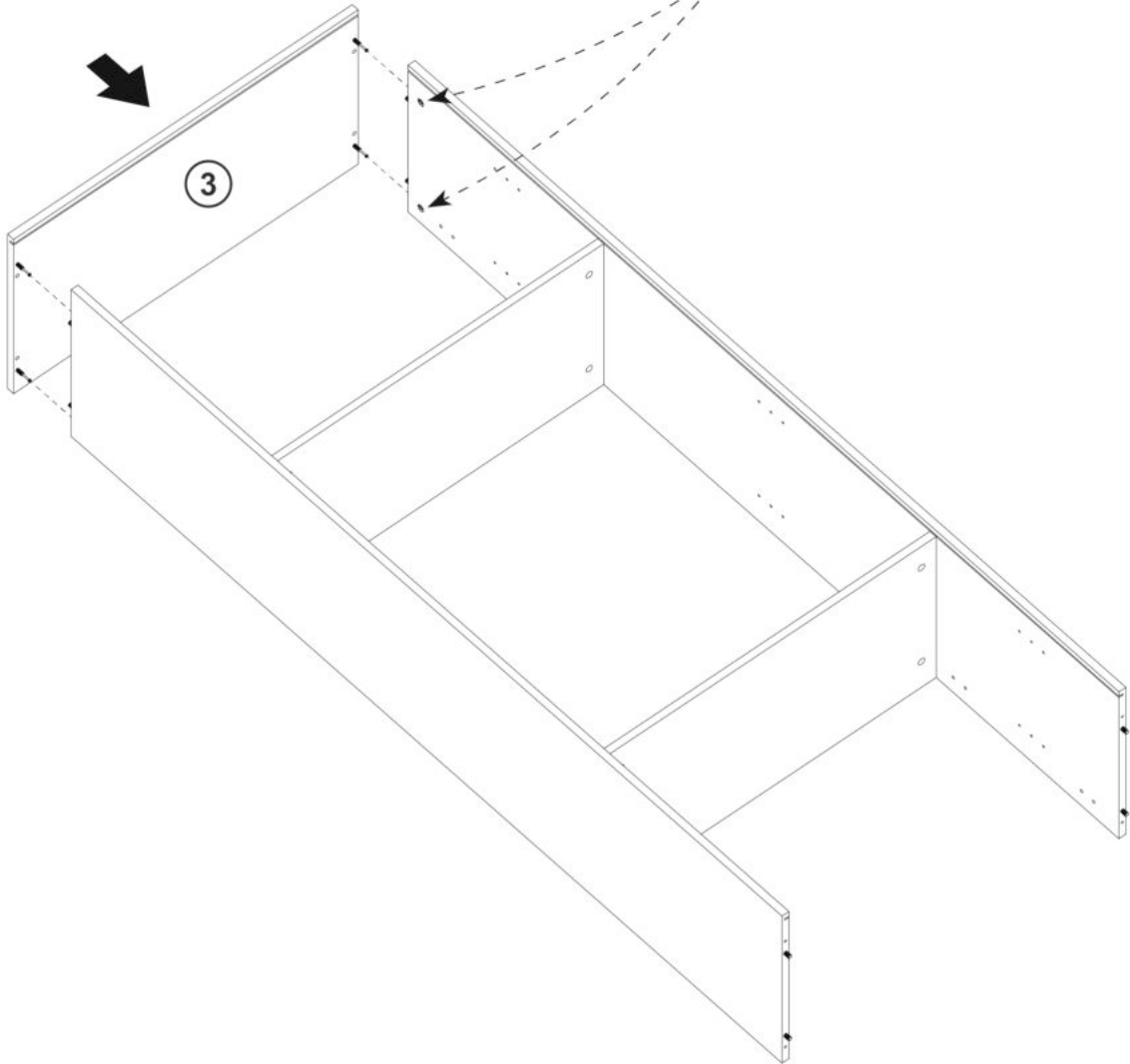
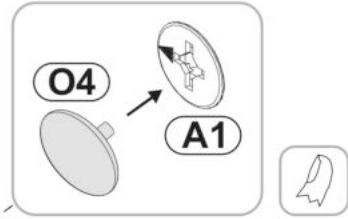

O4
Ø18 x4



6

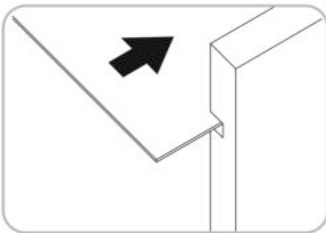
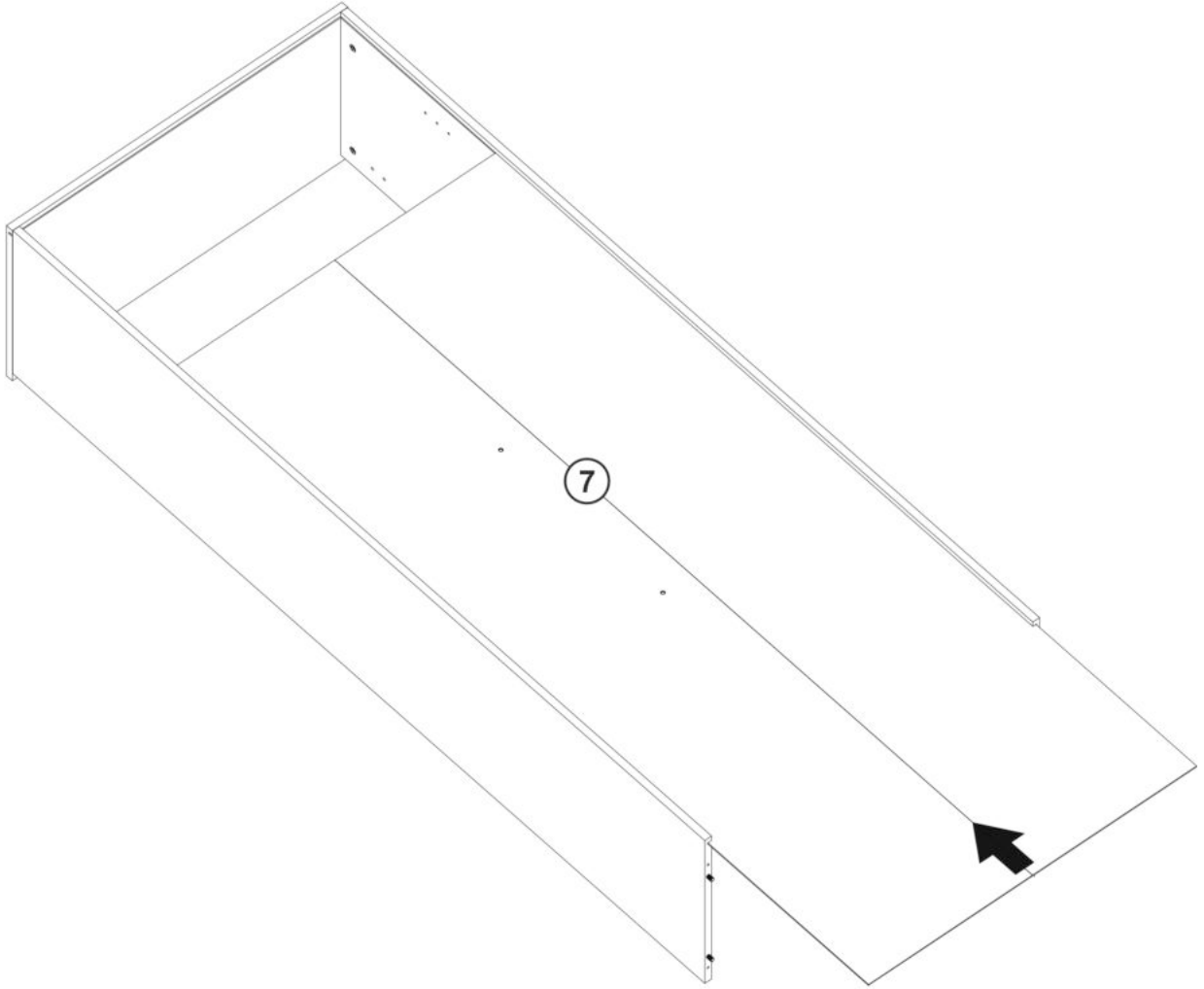
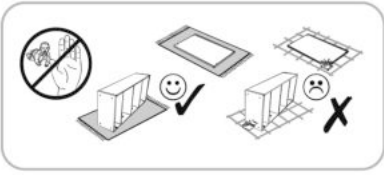

7

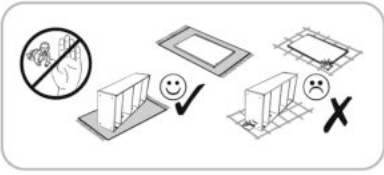

FA1
4mm x1

F3
6,3x50 x4

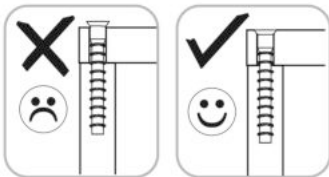
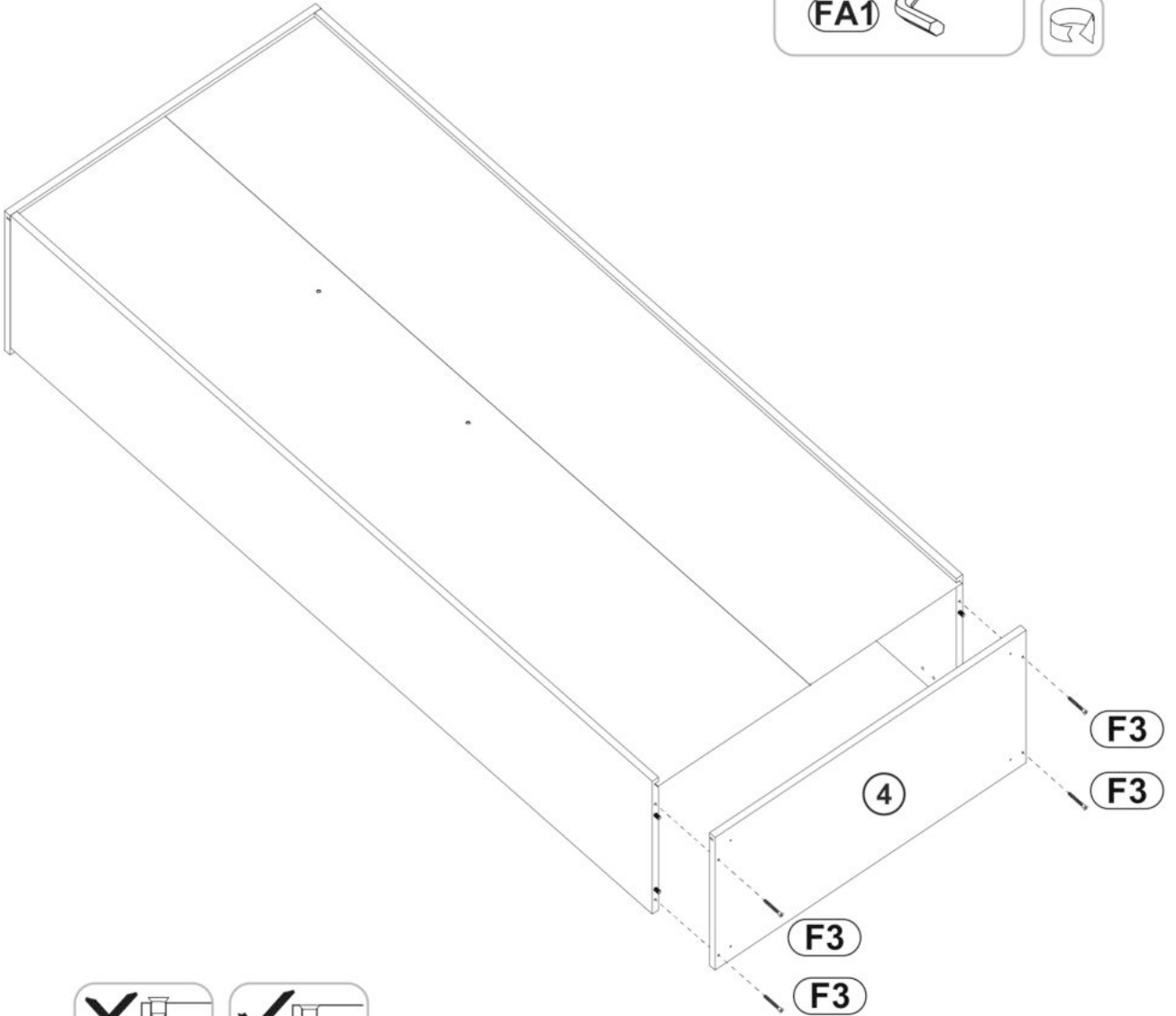
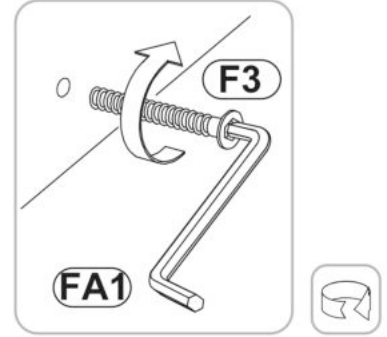

8

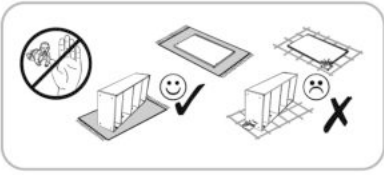

M1
10x10x15 x14

DA21
4,2x16 x4

P14
45x20 x4

D25
4x25 x4

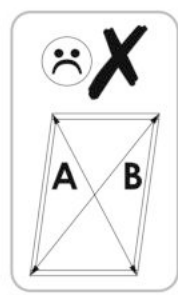
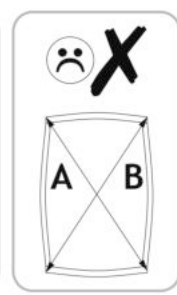
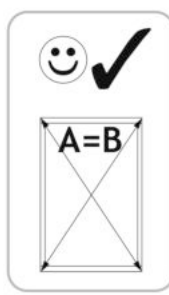
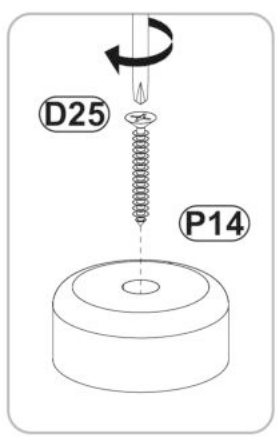
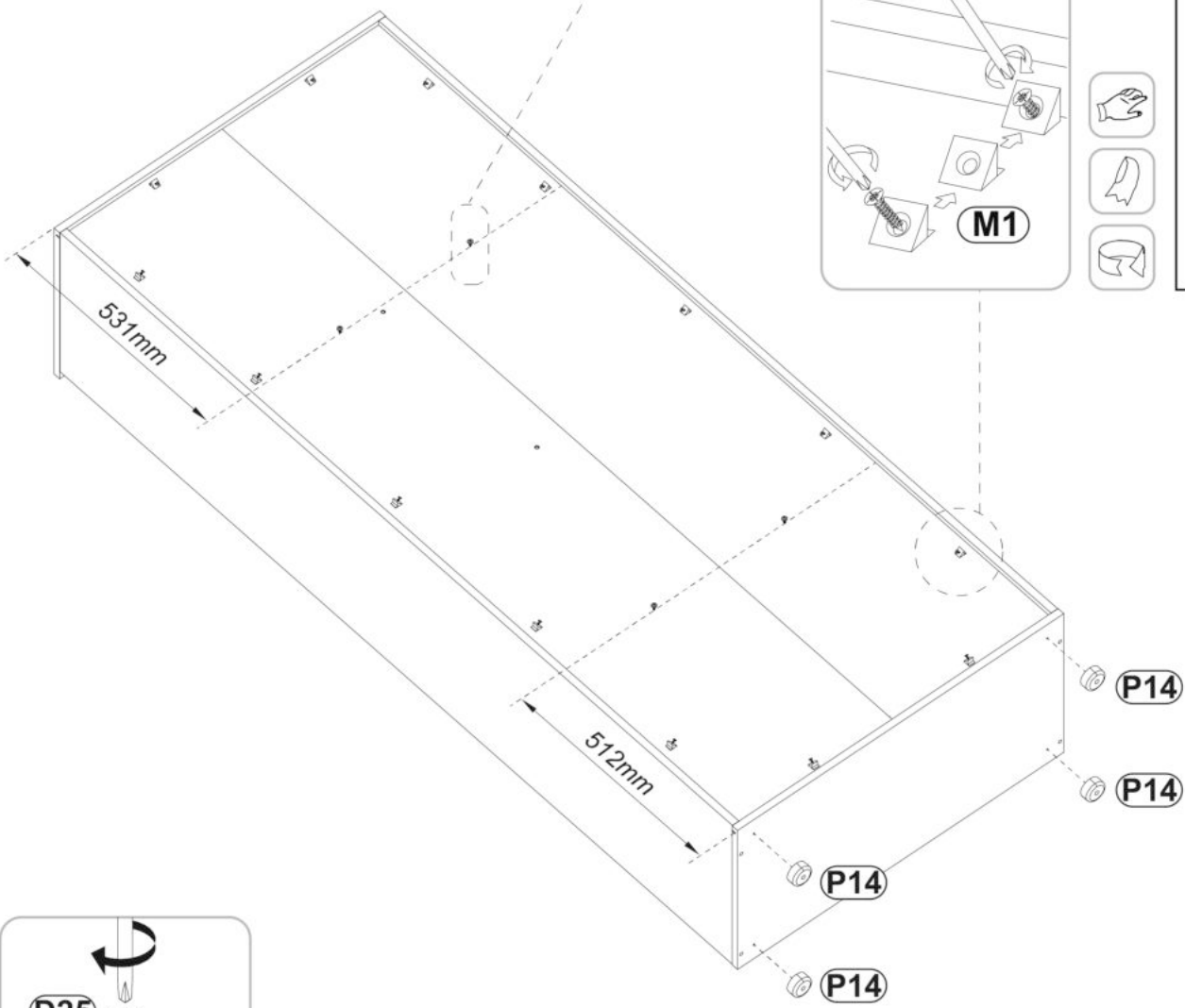
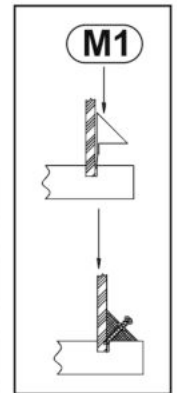
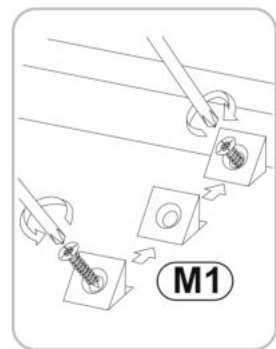
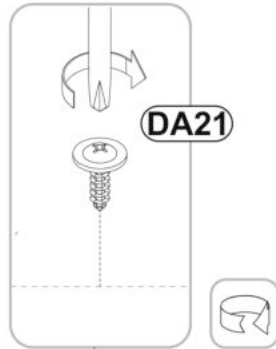
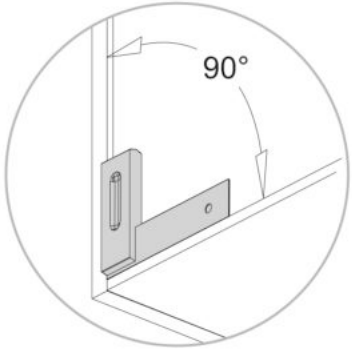

9

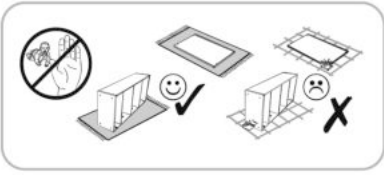

(N1)  x12
Ø6

(O5)  x2
Ø8

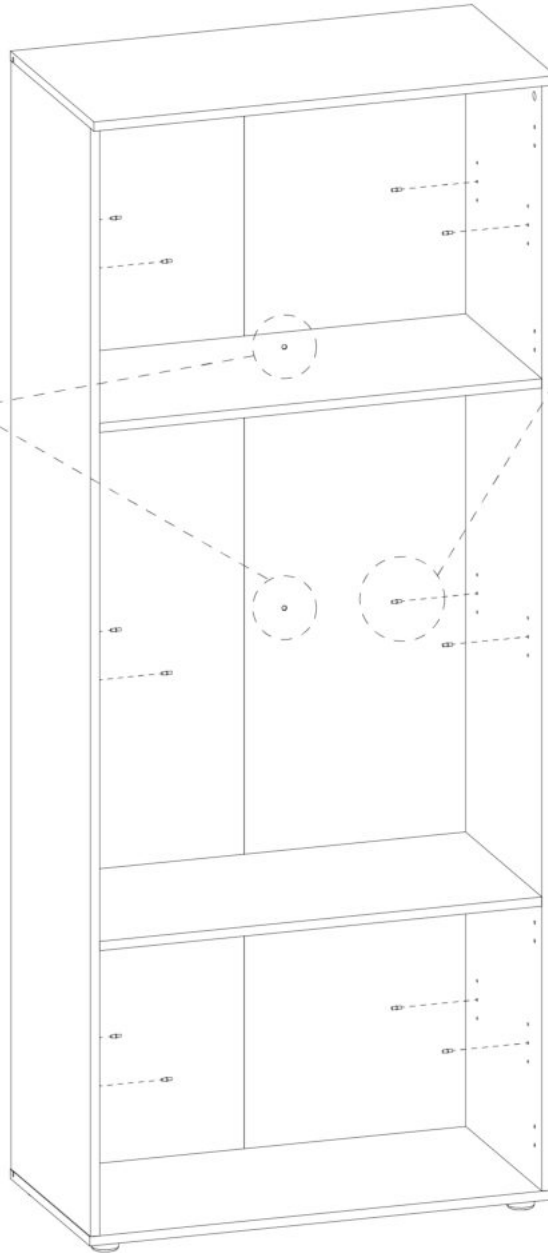
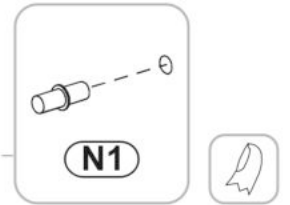
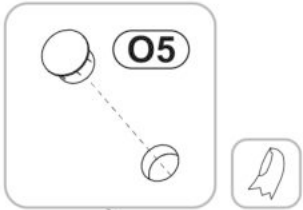

10

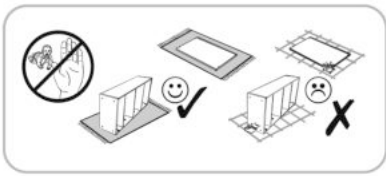

Y36
75x32x15 x1

Y37
8x50 x1

D11
3,5x16 x2

Y35
4,2x65 x1

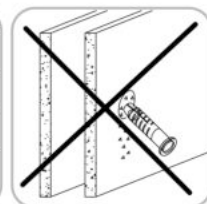
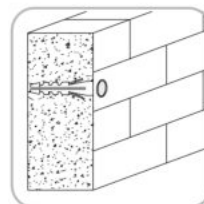
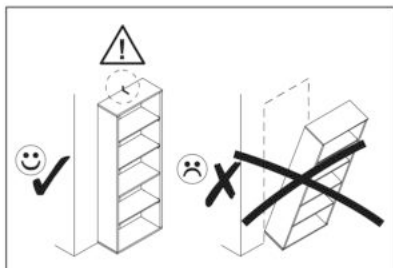
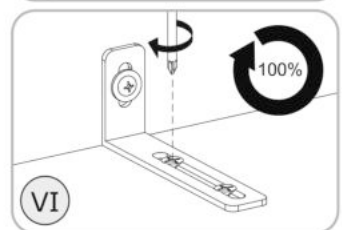
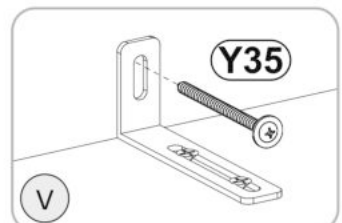
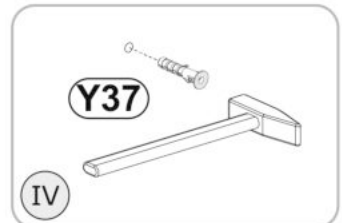
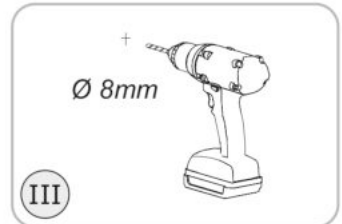
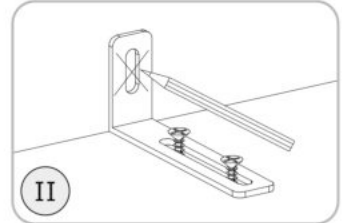
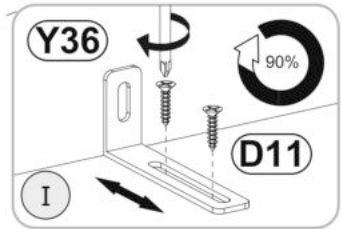
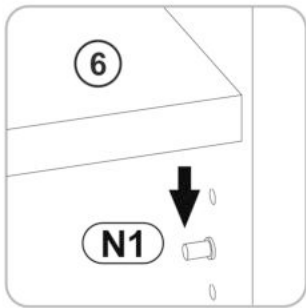
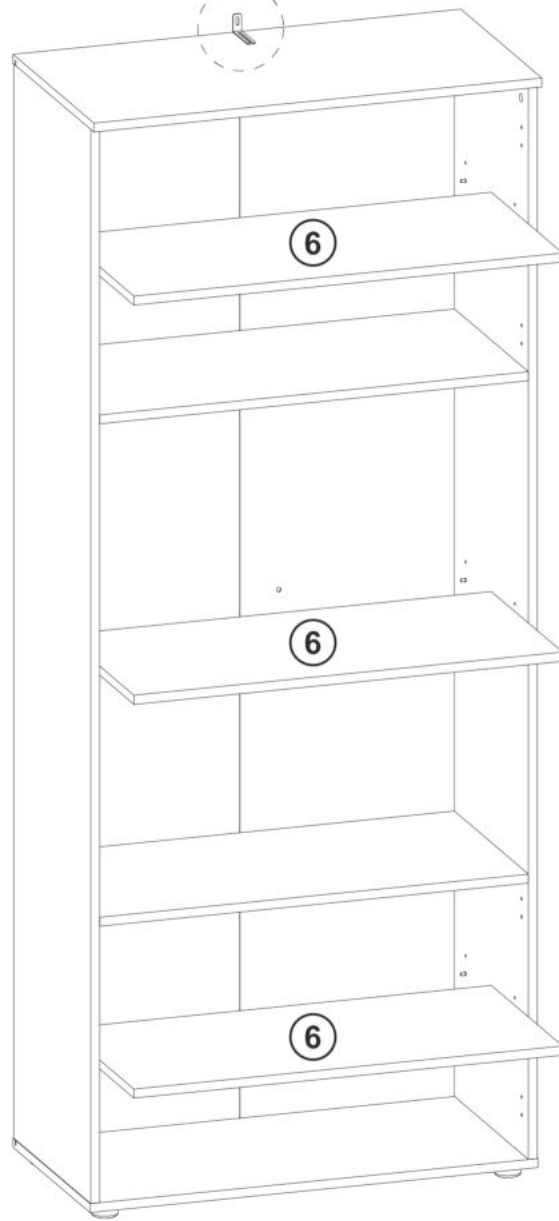

11

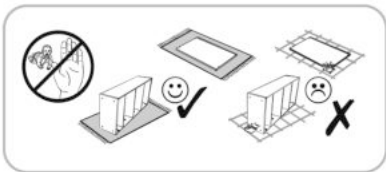

K6  **x4**
Ø35

D11  **x8**
3,5x16

R10  **x2**
Ø10

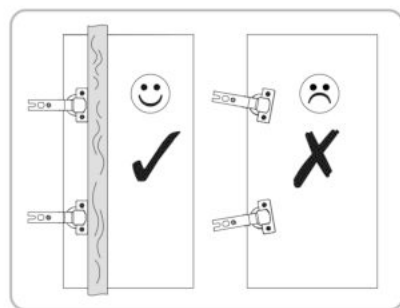
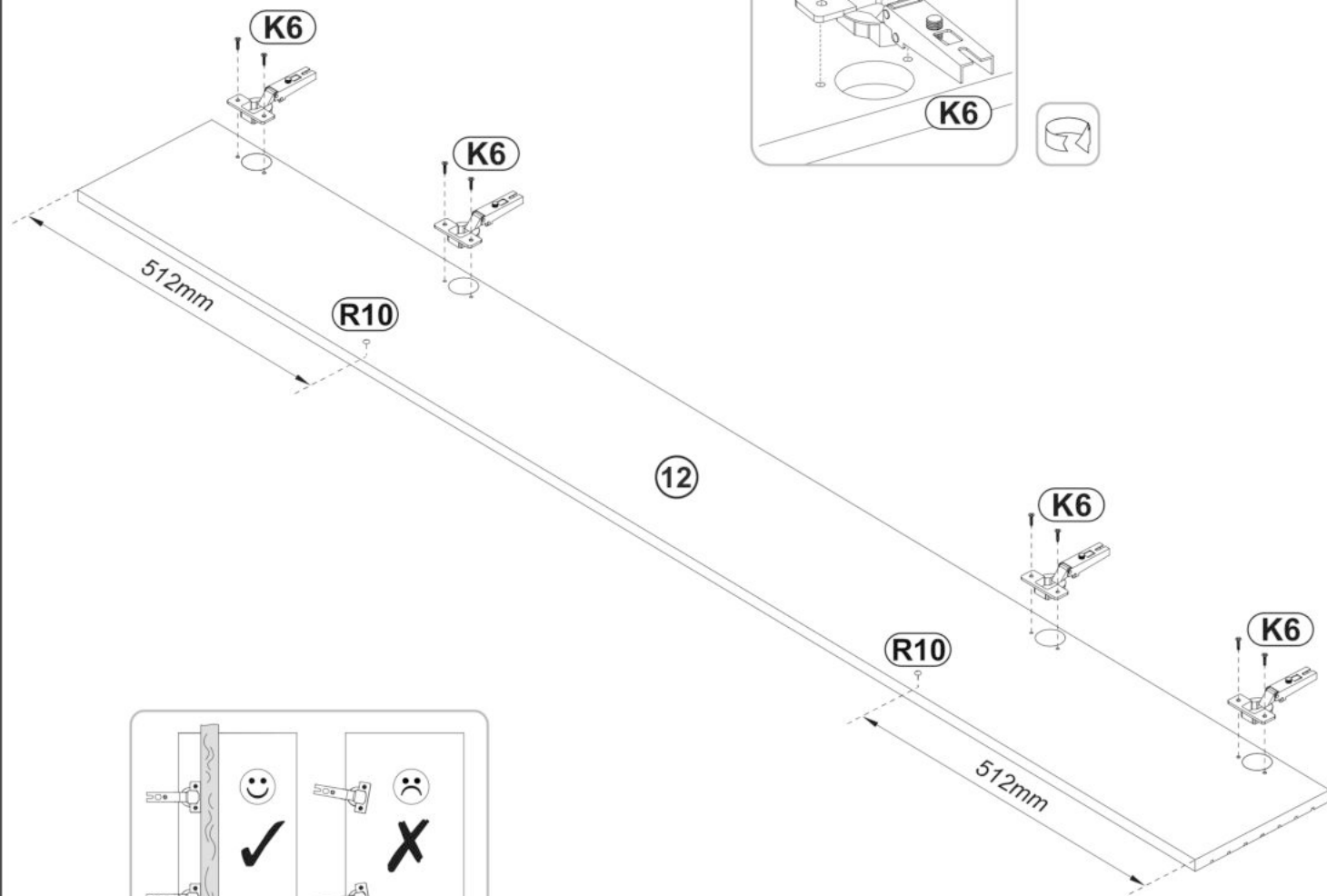
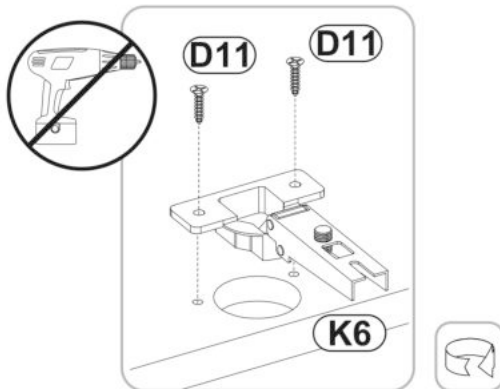

12

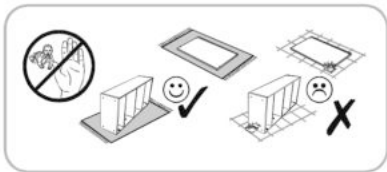

N5
10x6x10 x4

DA21
4,2x16 x4

R10
Ø10 x2

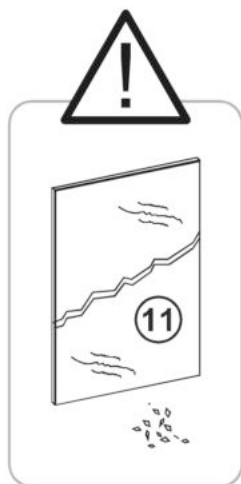
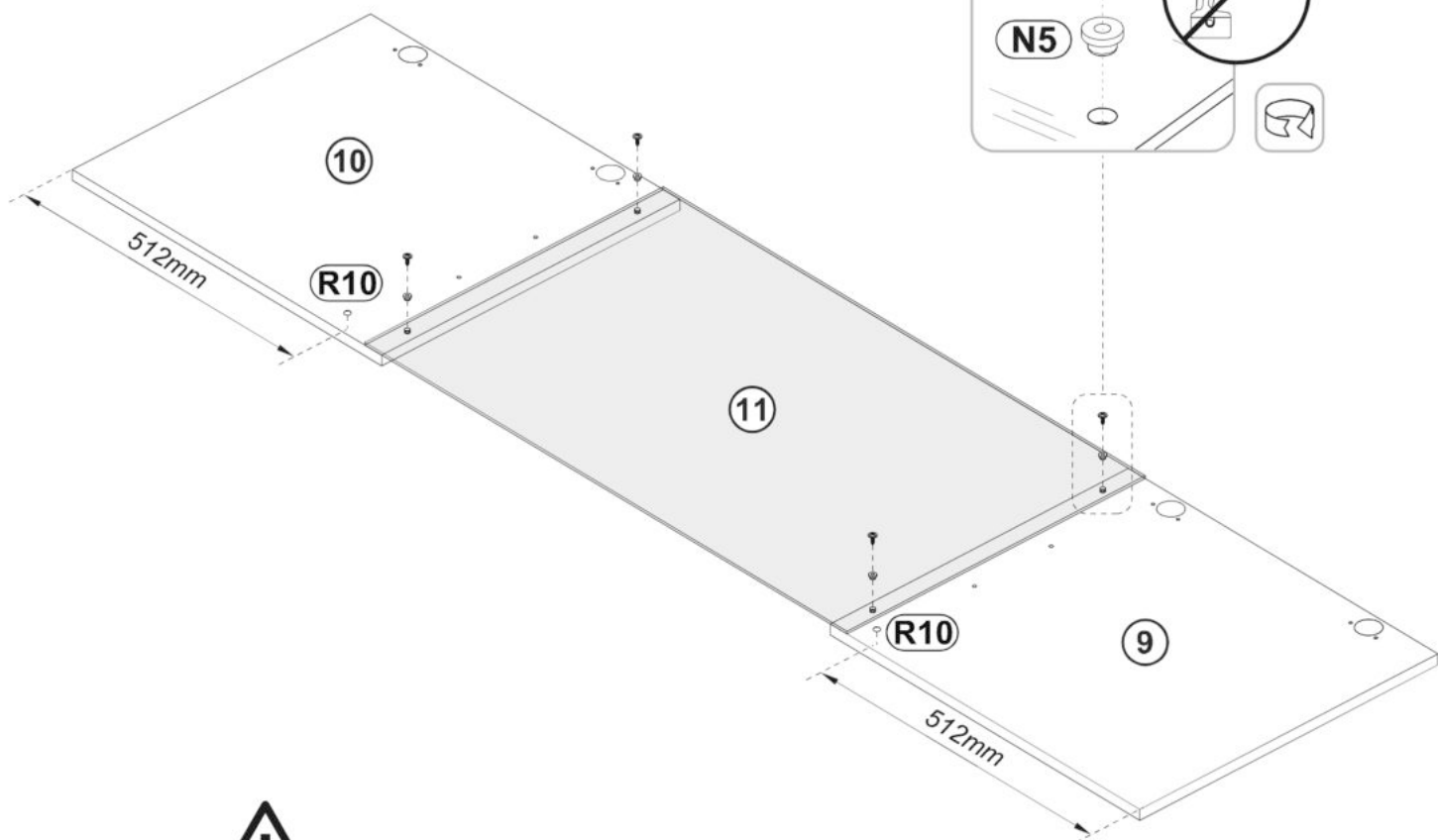
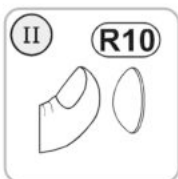

13

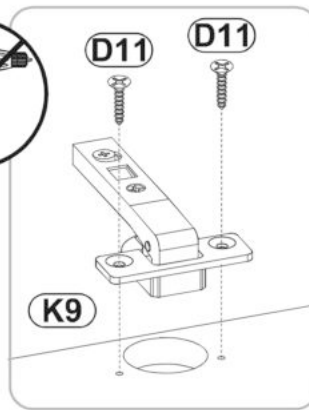
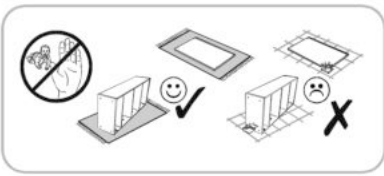

K9
Ø35 x4

D11
3,5x16 x8

DB2
4x25 x2

J65
128/148 x1

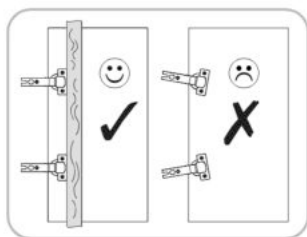
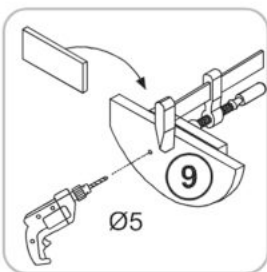
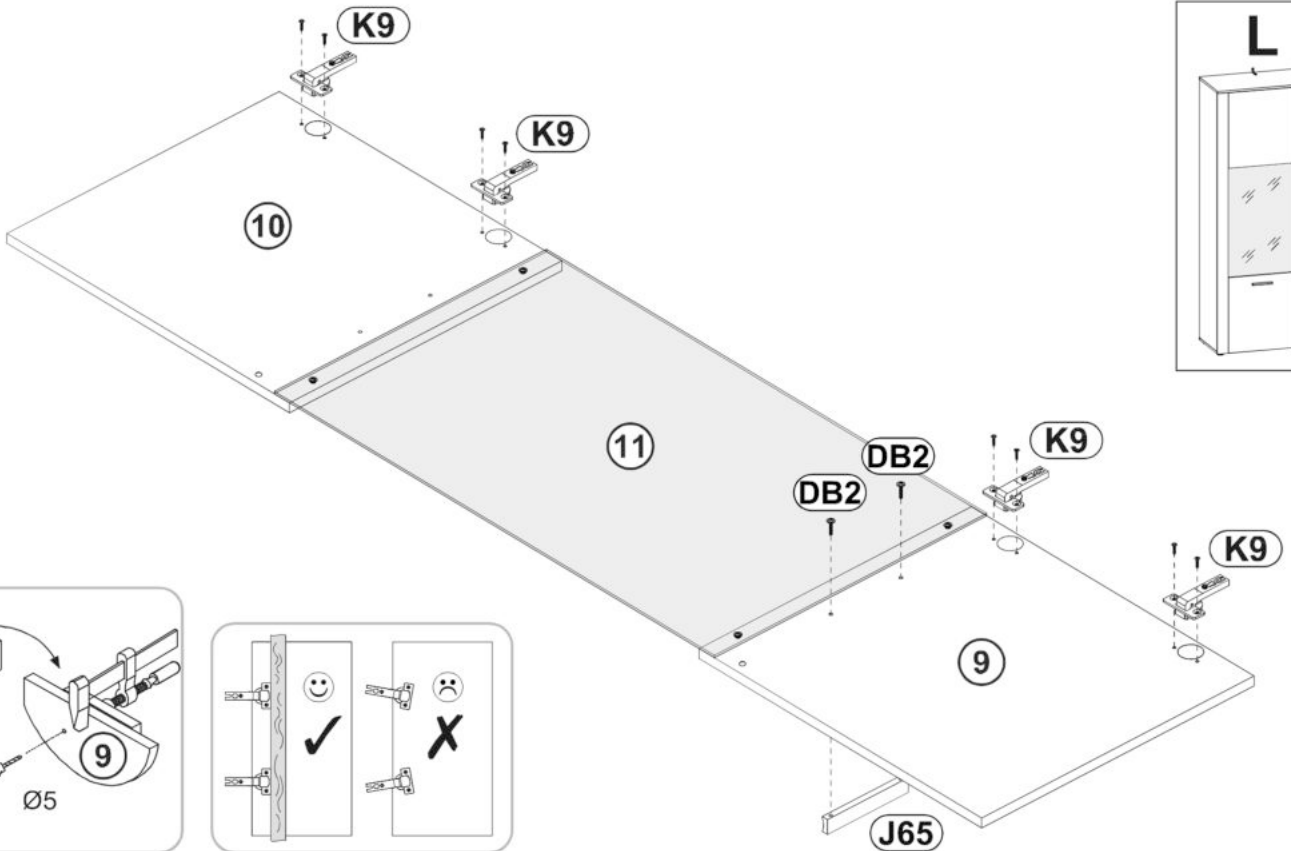
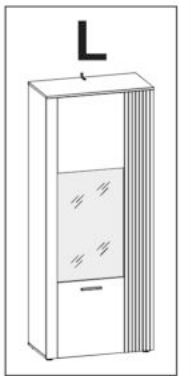
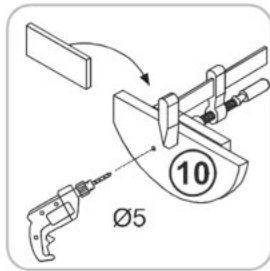
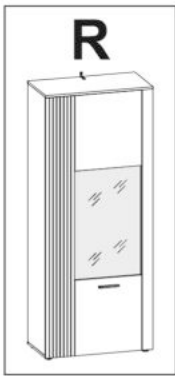
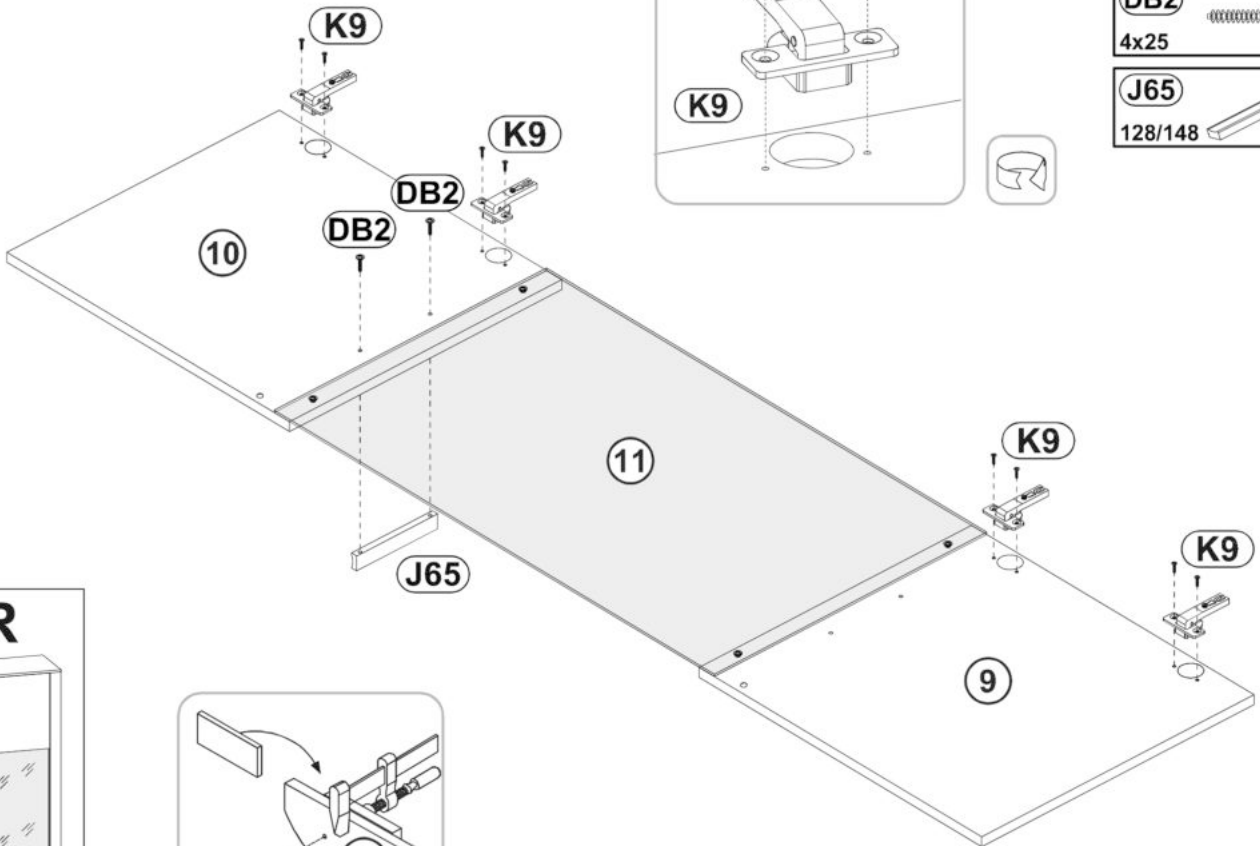

14

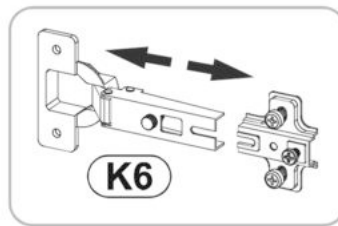
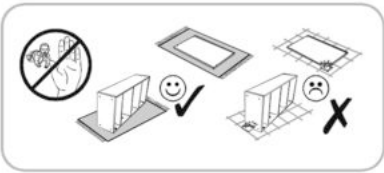

K6
Ø35  x4

DA21
4,2x16  x8

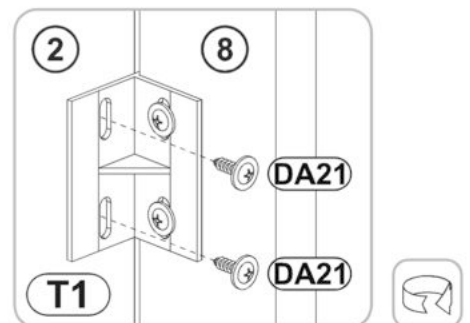
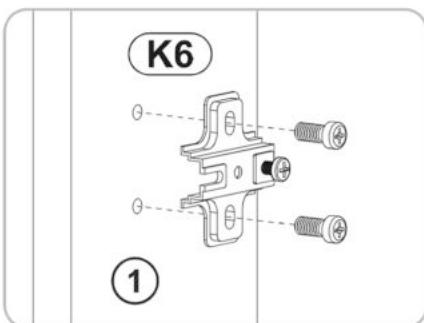
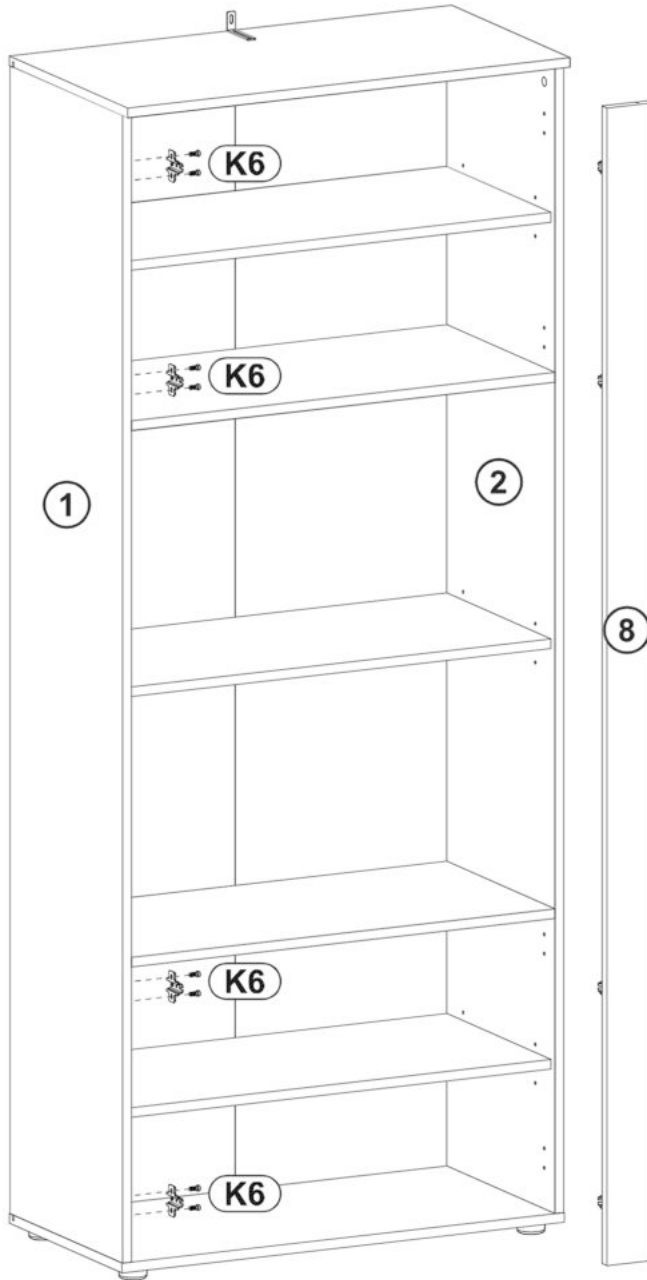
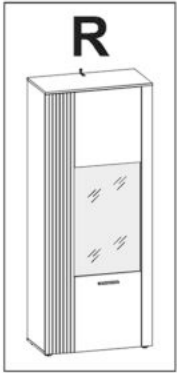

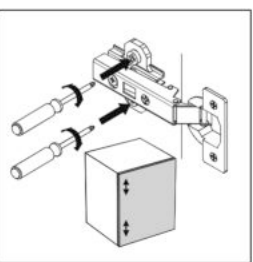
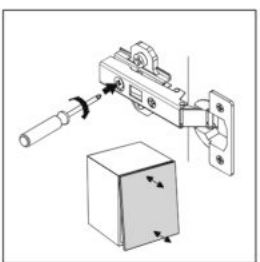
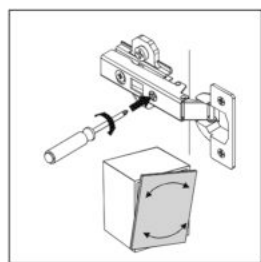
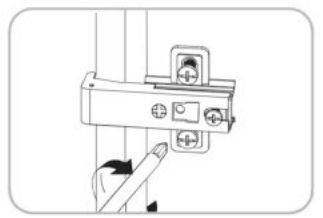
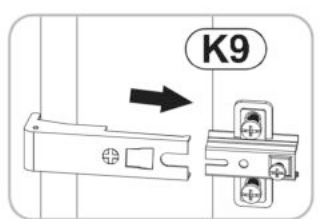
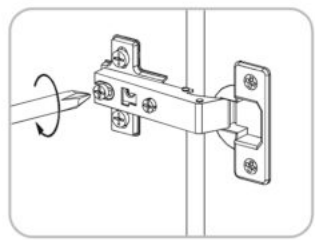
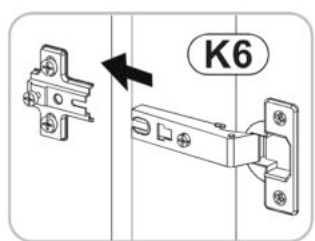
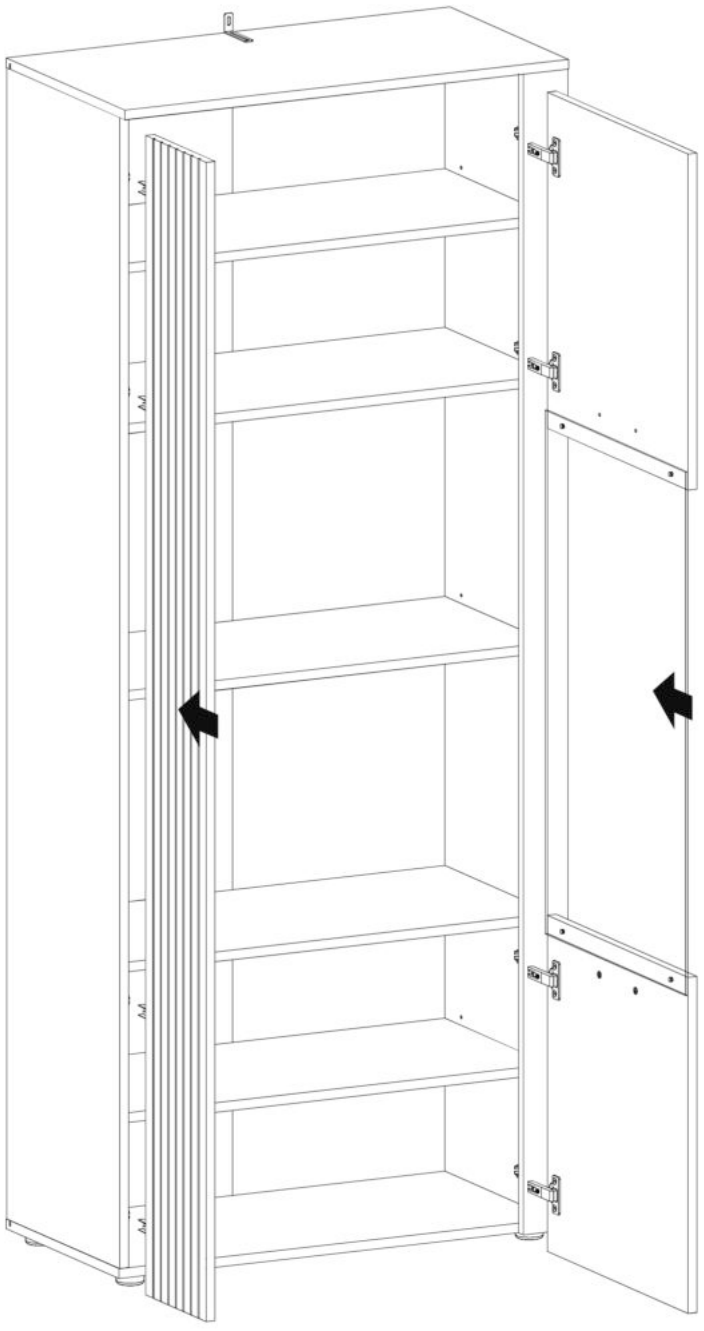
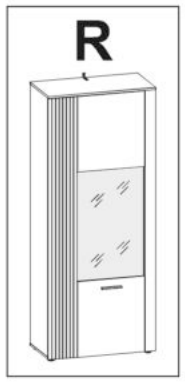
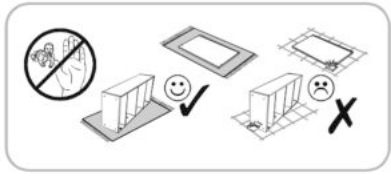

16

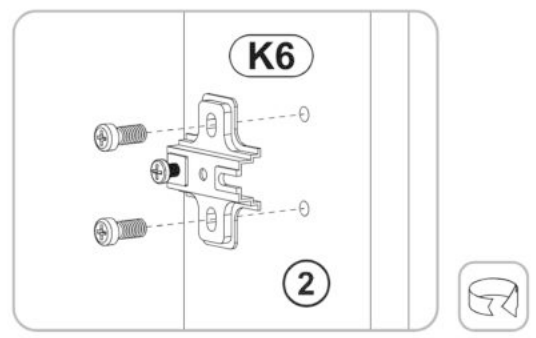
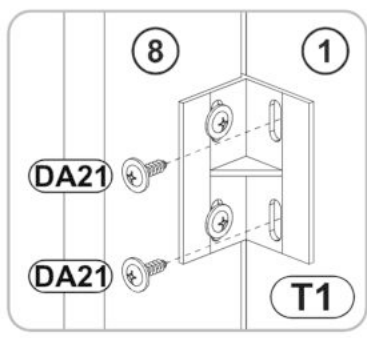
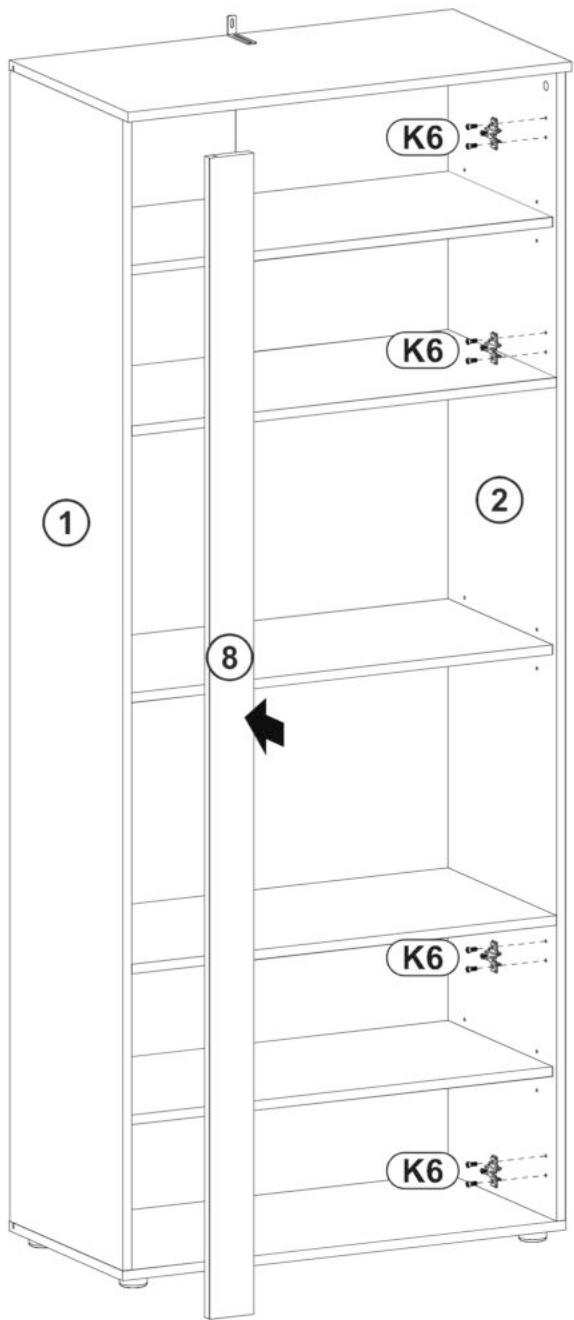
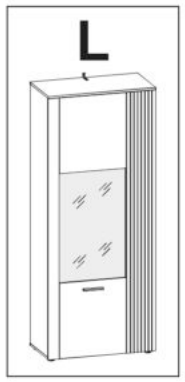
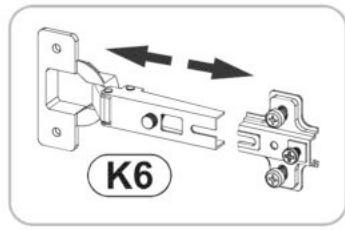
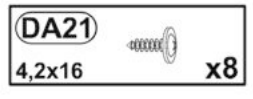
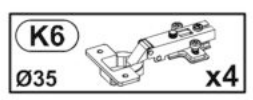
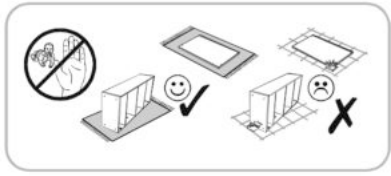

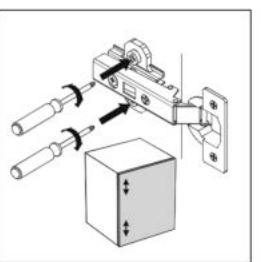
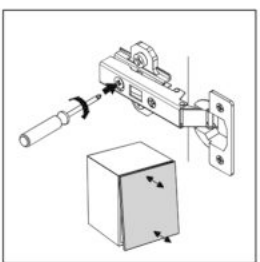
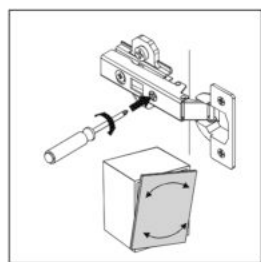
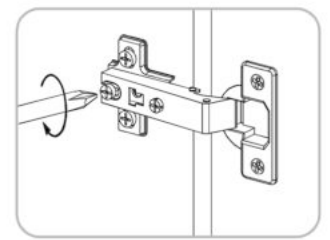
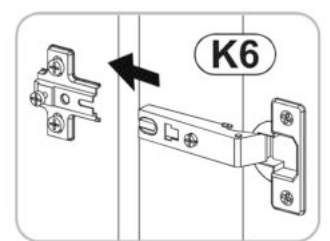
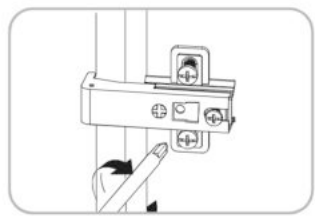
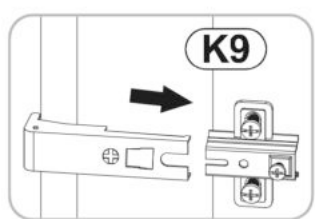
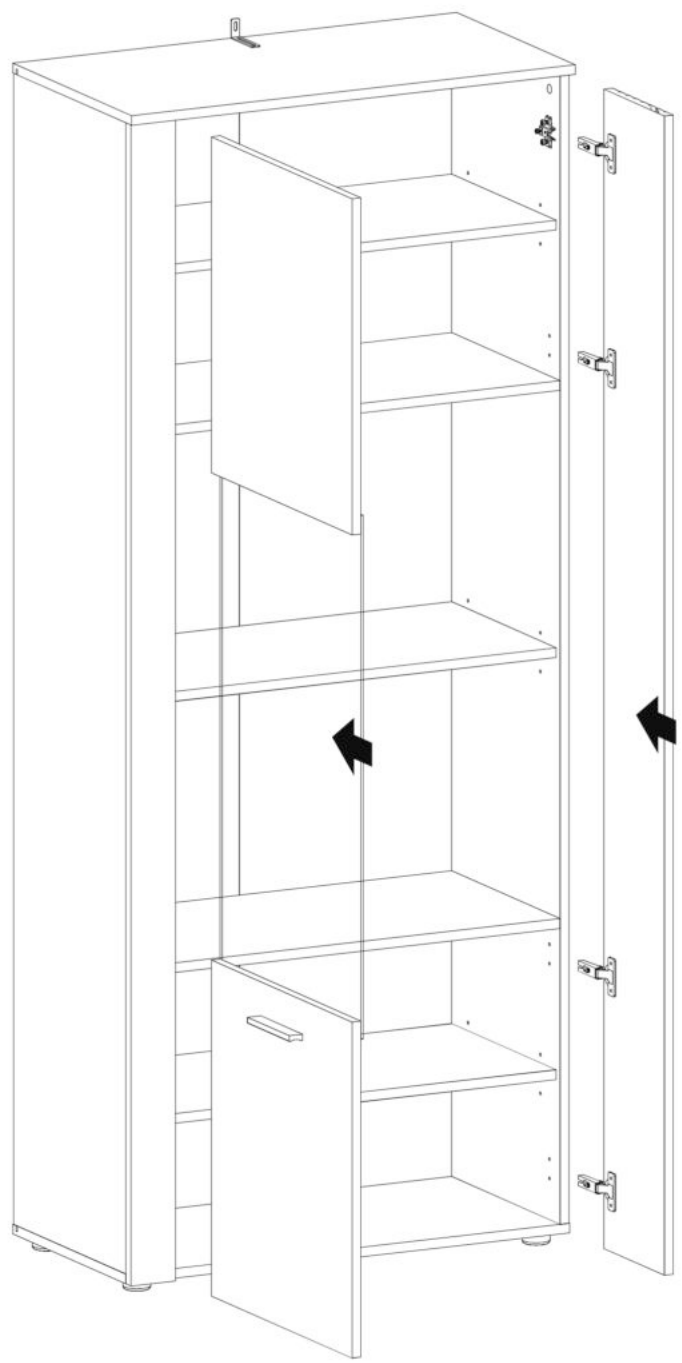
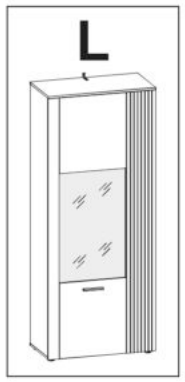
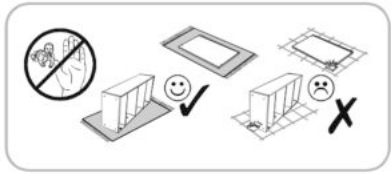



L

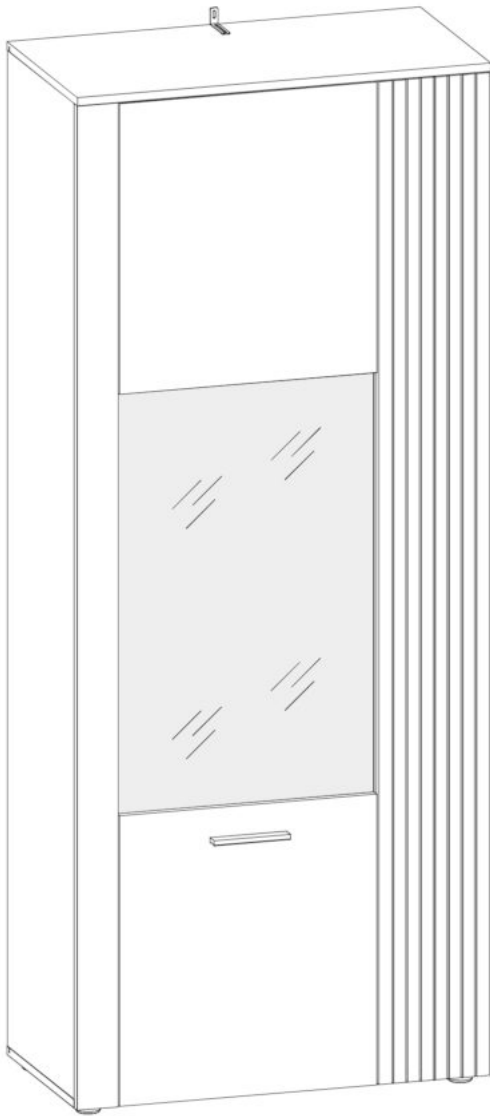

R

